

High Power Infrared Emitting Diode, 940 nm, GaAlAs, MQW

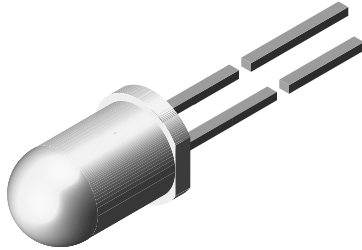

94 8389

RoHS
 COMPLIANT
 HALOGEN
FREE
GREEN
(5-2008)
FEATURES

- Package type: leaded
- Package form: T-1 $\frac{3}{4}$
- Dimensions (in mm): \varnothing 5
- Peak wavelength: $\lambda_p = 940$ nm
- High reliability
- High radiant power
- High radiant intensity
- Angle of half intensity: $\varphi = \pm 10^\circ$
- Low forward voltage
- Suitable for high pulse current operation
- Good spectral matching with Si photodetectors
- Material categorization: For definitions of compliance please see www.vishay.com/doc?99912

APPLICATIONS

- Infrared remote control units with high power requirements
- Free air transmission systems
- Infrared source for optical counters and card readers
- IR source for smoke detectors

DESCRIPTION

TSAL6100 is an infrared, 940 nm emitting diode in GaAlAs multi quantum well (MQW) technology with high radiant power and high speed molded in a blue-gray plastic package.

| PRODUCT SUMMARY | | | | |
|-----------------|---------------|-----------------|------------------|------------|
| COMPONENT | I_e (mW/sr) | φ (deg) | λ_p (nm) | t_r (ns) |
| TSAL6100 | 170 | ± 10 | 940 | 15 |

Note

- Test conditions see table "Basic Characteristics"

| ORDERING INFORMATION | | | |
|----------------------|-----------|------------------------------|-------------------|
| ORDERING CODE | PACKAGING | REMARKS | PACKAGE FORM |
| TSAL6100 | Bulk | MOQ: 4000 pcs, 4000 pcs/bulk | T-1 $\frac{3}{4}$ |

Note

- MOQ: minimum order quantity

| ABSOLUTE MAXIMUM RATINGS ($T_{amb} = 25^\circ\text{C}$, unless otherwise specified) | | | | |
|---|---------------------------------------|------------|-------------|------------------|
| PARAMETER | TEST CONDITION | SYMBOL | VALUE | UNIT |
| Reverse voltage | | V_R | 5 | V |
| Forward current | | I_F | 100 | mA |
| Peak forward current | $t_p/T = 0.5, t_p = 100 \mu\text{s}$ | I_{FM} | 200 | mA |
| Surge forward current | $t_p = 100 \mu\text{s}$ | I_{FSM} | 1.5 | A |
| Power dissipation | | P_V | 160 | mW |
| Junction temperature | | T_j | 100 | $^\circ\text{C}$ |
| Operating temperature range | | T_{amb} | -40 to +85 | $^\circ\text{C}$ |
| Storage temperature range | | T_{stg} | -40 to +100 | $^\circ\text{C}$ |
| Soldering temperature | $t \leq 5$ s, 2 mm from case | T_{sd} | 260 | $^\circ\text{C}$ |
| Thermal resistance junction/ambient | J-STD-051, leads 7 mm soldered on PCB | R_{thJA} | 230 | K/W |

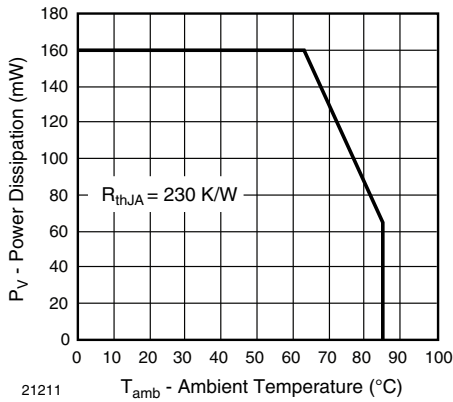

Fig. 1 - Power Dissipation Limit vs. Ambient Temperature

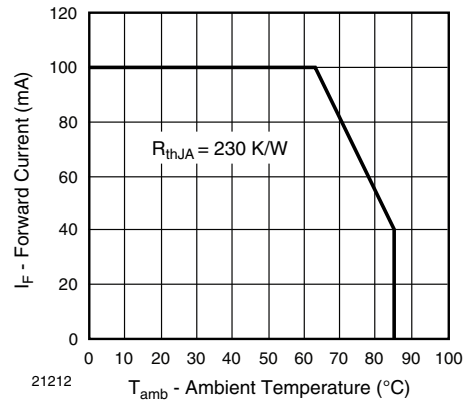

Fig. 2 - Forward Current Limit vs. Ambient Temperature

| BASIC CHARACTERISTICS ($T_{amb} = 25\text{ }^{\circ}\text{C}$, unless otherwise specified) | | | | | | |
|---|---|------------------|------|----------|------|---------------|
| PARAMETER | TEST CONDITION | SYMBOL | MIN. | TYP. | MAX. | UNIT |
| Forward voltage | $I_F = 100\text{ mA}$, $t_p = 20\text{ ms}$ | V_F | | 1.35 | 1.6 | V |
| | $I_F = 1\text{ A}$, $t_p = 100\text{ }\mu\text{s}$ | V_F | | 2.2 | 3 | V |
| Temperature coefficient of V_F | $I_F = 1\text{ mA}$ | TK_{V_F} | | -1.8 | | mV/K |
| Reverse current | $V_R = 5\text{ V}$ | I_R | | | 10 | μA |
| Junction capacitance | $V_R = 0\text{ V}$, $f = 1\text{ MHz}$, $E = 0$ | C_j | | 40 | | pF |
| Radiant intensity | $I_F = 100\text{ mA}$, $t_p = 20\text{ ms}$ | I_e | 80 | 170 | 400 | mW/sr |
| | $I_F = 1\text{ A}$, $t_p = 100\text{ }\mu\text{s}$ | I_e | 650 | 1450 | | mW/sr |
| Radiant power | $I_F = 100\text{ mA}$, $t_p = 20\text{ ms}$ | ϕ_e | | 40 | | mW |
| Temperature coefficient of ϕ_e | $I_F = 20\text{ mA}$ | TK_{ϕ_e} | | -0.6 | | %/K |
| Angle of half intensity | | φ | | ± 10 | | deg |
| Peak wavelength | $I_F = 100\text{ mA}$ | λ_p | | 940 | | nm |
| Spectral bandwidth | $I_F = 100\text{ mA}$ | $\Delta\lambda$ | | 30 | | nm |
| Temperature coefficient of λ_p | $I_F = 100\text{ mA}$ | TK_{λ_p} | | 0.2 | | nm/K |
| Rise time | $I_F = 100\text{ mA}$ | t_r | | 15 | | ns |
| Fall time | $I_F = 100\text{ mA}$ | t_f | | 15 | | ns |

BASIC CHARACTERISTICS ($T_{amb} = 25\text{ }^{\circ}\text{C}$, unless otherwise specified)

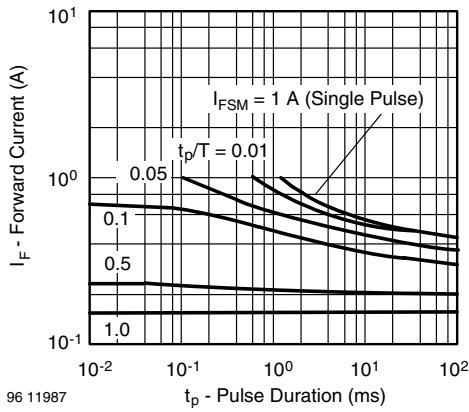

Fig. 3 - Pulse Forward Current vs. Pulse Duration

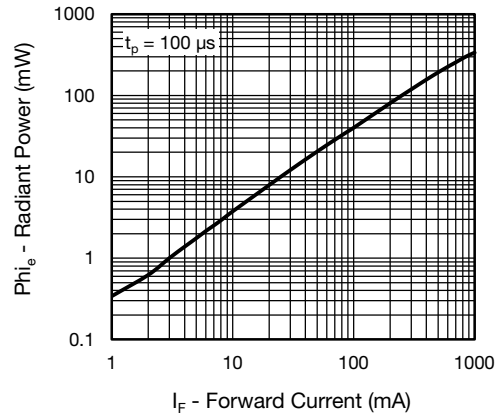

Fig. 6 - Radiant Power vs. Forward Current

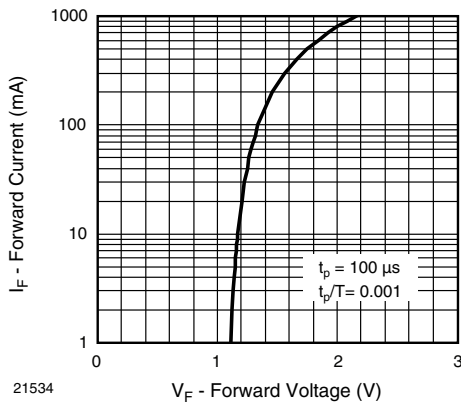

Fig. 4 - Forward Current vs. Forward Voltage

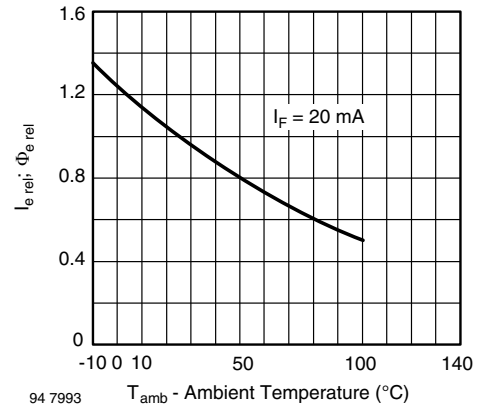

Fig. 7 - Rel. Radiant Intensity/Power vs. Ambient Temperature

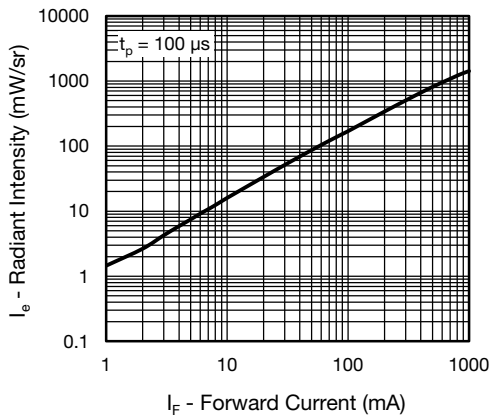

Fig. 5 - Radiant Intensity vs. Forward Current

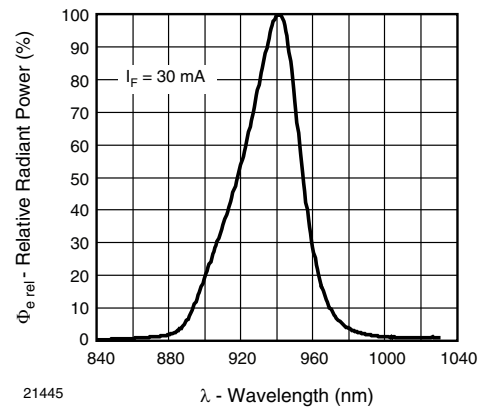

Fig. 8 - Relative Radiant Power vs. Wavelength

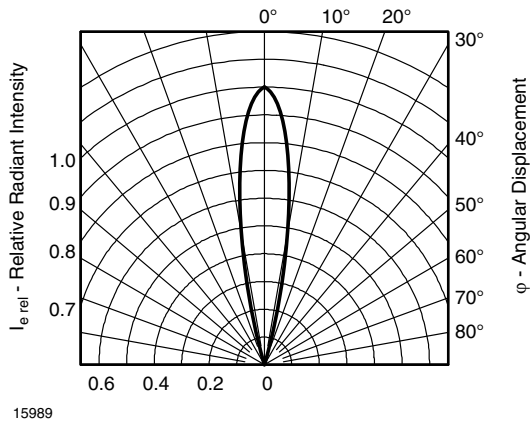
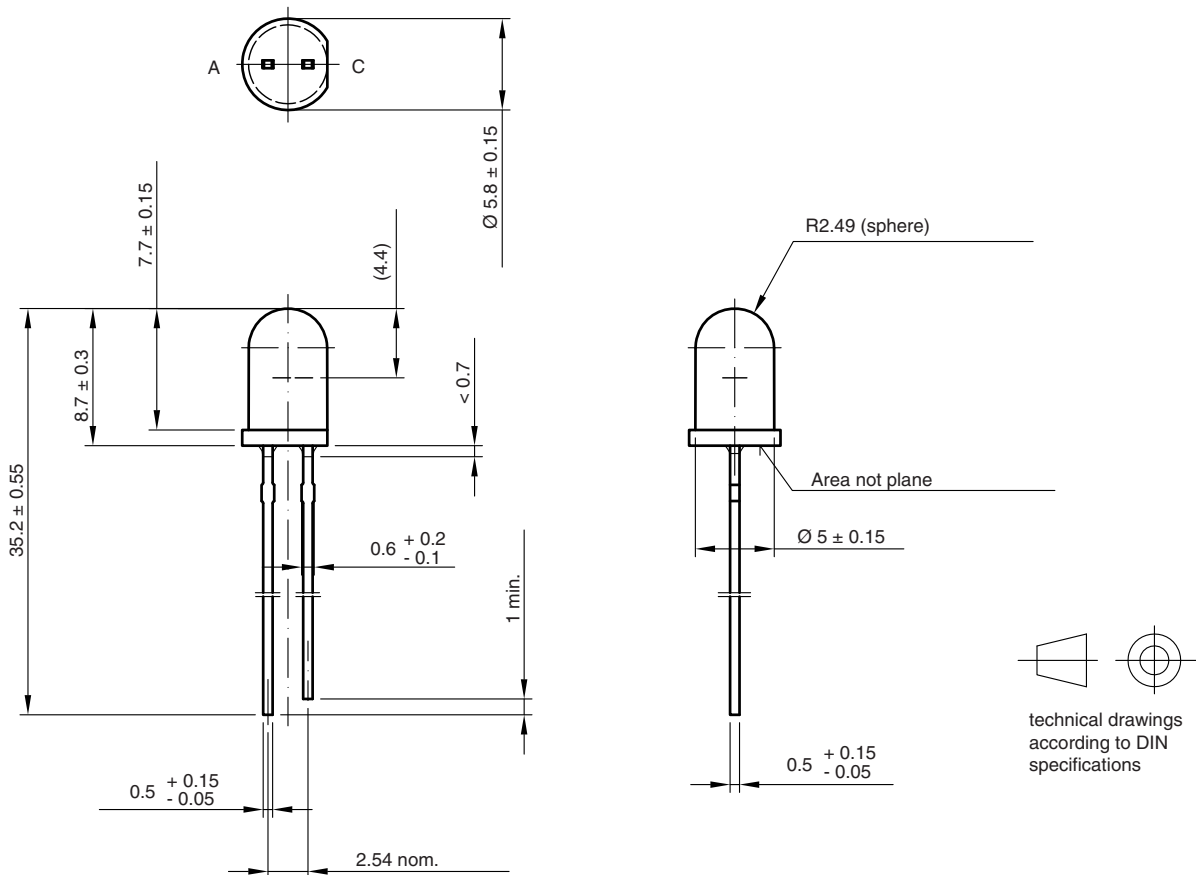

Fig. 9 - Relative Radiant Intensity vs. Angular Displacement

PACKAGE DIMENSIONS in millimeters



6.544-5259.08-4
 Issue: 3; 19.05.09
 14436



Disclaimer

ALL PRODUCT, PRODUCT SPECIFICATIONS AND DATA ARE SUBJECT TO CHANGE WITHOUT NOTICE TO IMPROVE RELIABILITY, FUNCTION OR DESIGN OR OTHERWISE.

Vishay Intertechnology, Inc., its affiliates, agents, and employees, and all persons acting on its or their behalf (collectively, "Vishay"), disclaim any and all liability for any errors, inaccuracies or incompleteness contained in any datasheet or in any other disclosure relating to any product.

Vishay makes no warranty, representation or guarantee regarding the suitability of the products for any particular purpose or the continuing production of any product. To the maximum extent permitted by applicable law, Vishay disclaims (i) any and all liability arising out of the application or use of any product, (ii) any and all liability, including without limitation special, consequential or incidental damages, and (iii) any and all implied warranties, including warranties of fitness for particular purpose, non-infringement and merchantability.

Statements regarding the suitability of products for certain types of applications are based on Vishay's knowledge of typical requirements that are often placed on Vishay products in generic applications. Such statements are not binding statements about the suitability of products for a particular application. It is the customer's responsibility to validate that a particular product with the properties described in the product specification is suitable for use in a particular application. Parameters provided in datasheets and / or specifications may vary in different applications and performance may vary over time. All operating parameters, including typical parameters, must be validated for each customer application by the customer's technical experts. Product specifications do not expand or otherwise modify Vishay's terms and conditions of purchase, including but not limited to the warranty expressed therein.

Except as expressly indicated in writing, Vishay products are not designed for use in medical, life-saving, or life-sustaining applications or for any other application in which the failure of the Vishay product could result in personal injury or death. Customers using or selling Vishay products not expressly indicated for use in such applications do so at their own risk. Please contact authorized Vishay personnel to obtain written terms and conditions regarding products designed for such applications.

No license, express or implied, by estoppel or otherwise, to any intellectual property rights is granted by this document or by any conduct of Vishay. Product names and markings noted herein may be trademarks of their respective owners.

Mouser Electronics

Authorized Distributor

Click to View Pricing, Inventory, Delivery & Lifecycle Information:

[Vishay:](#)

[TSAL6100](#) [TSAL6100X01](#)